

Professional Charger Specification
GP version

P461 (charge pack), D461 (4-slot dock), D861 (8-slot dock)

System setup

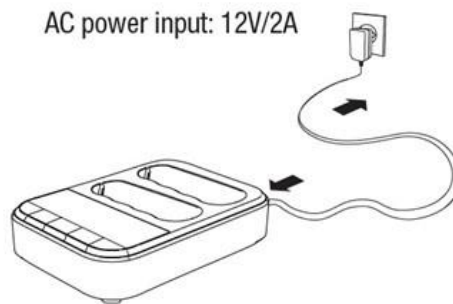
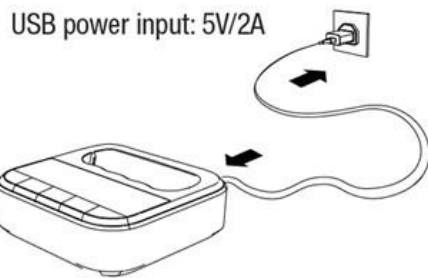

P461 Battery Charger

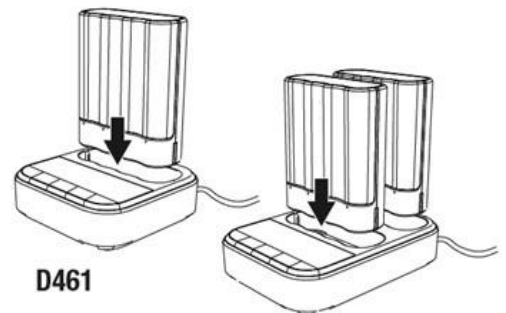
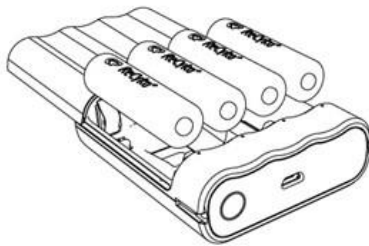

D461

D861

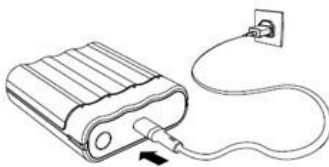
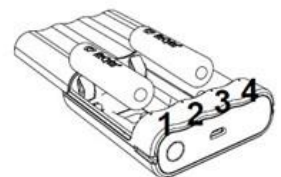
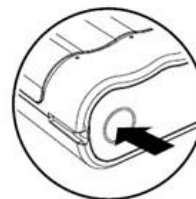
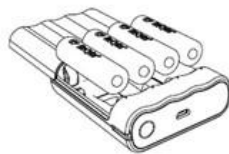

Fig. 1a





Professional Charger Specification

GP version

P461 (charge pack), D461 (4-slot dock), D861 (8-slot dock)

P461: Charge Pack

Scope:

This is a Ni-MH battery smart charge organizer with 4 Individual channels.

If no other specified on the test condition, all of the data specified are at room temperature – 25C, voltage and current are tested at the point of the input and the batteries contact plates

Rated input voltage/current: DC 5.0V/2.0A (microUSB socket)

Operation Mode

- 1) Standalone mode: working with standard microUSB power 5V/2A supply
- 2) System mode: working with dock unit D461/ D861

Rated charging current: Average current at DC 5.0V 2.0A, @ Battery voltage as 1.4V

FAST mode charging

AA size:	2pcs 1730mA	(1.3hr for 2100mAh)
	4pcs 865mA	(2.6hr for 2100mAh)

AAA size:	2pcs 700mA	(1.4hr for 850mAh)
	4pcs 350mA	(2.8hr for 850mAh)

ECO mode charging

AA size:	2pcs 865mA	(2.6hr for 2100mAh)
	4pcs 432mA	(5.2hr for 2100mAh)

AAA size:	2pcs 350mA	(2.8hr for 850mAh)
	4pcs 175mA	(5.6hr for 850mAh)



Professional Charger Specification

GP version

P461 (charge pack), D461 (4-slot dock), D861 (8-slot dock)

FAST mode (also able to work in standalone with microUSB power 5V/2A)**For AA size battery:**CH1 & CH2 only

- (1*AA size): 1730mA +/- 10% (continuous 1730mA charge)
- (2*AA size): 865mA +/-10% (1sec 1730mA charge, 1sec charging OFF)

CH3 & CH4 only

- (1*AA size): 1730mA +/-10% (continuous 1730mA charge)
- (2*AA size): 865mA +/-10% (1sec 1730mA charge, 1sec charging OFF)

CH1 & CH2 + CH3 & CH4:

- CH1 & CH2 (1*AA size): 1730mA +/- 10% (continuous 1730mA charge)
- CH3 & CH4 (1*AA size): 1730mA +/- 10% (continuous 1730mA charge)

CH1 & CH2 + CH3 & CH4:

- CH1 & CH2 (1*AA size): 865mA +/-10% (1sec 1730mA charge, 1sec charging OFF)
- CH3 & CH4 (2*AA size): 865mA +/-10% (1sec 1730mA charge, 1sec charging OFF)

CH1 & CH2 + CH3 & CH4:

- CH1 & CH2 (2*AA size): 865mA +/-10% (1sec 1730mA charge, 1sec charging OFF)
- CH3 & CH4 (1*AA size): 865mA +/-10% (1sec 1730mA charge, 1sec charging OFF)

CH1 & CH2 + CH3 & CH4:

- CH1 & CH2 (2*AA size): 865mA +/-10% (1sec 1730mA charge, 1sec charging OFF)
- CH3 & CH4 (2*AA size): 865mA +/-10% (1sec 1730mA charge, 1sec charging OFF)

For AAA size battery:CH1 & CH2 only

- (1*AAA size): 700mA +/-10% (continuous 700mA charge)
- (2*AAA size): 350mA +/-10% (1sec 700mA charge, 1sec charging OFF)

CH3 & CH4 only

- (1*AAA size): 700mA +/-10% (continuous 700mA charge)
- (2*AAA size): 350mA +/-10% (1sec 700mA charge, 1sec charging OFF)

CH1 & CH2 + CH3 & CH4:

- CH1 & CH2 (1*AAA size): 700mA +/-10% (continuous 700mA charge)
- CH3 & CH4 (1*AAA size): 700mA +/-10% (continuous 700mA charge)

CH1 & CH2 + CH3 & CH4:

- CH1 & CH2 (1*AAA size): 350mA +/-10% (1sec 700mA charge, 1sec charging OFF)
- CH3 & CH4 (2*AAA size): 350mA +/-10% (1sec 700mA charge, 1sec charging OFF)

CH1 & CH2 + CH3 & CH4:

- CH1 & CH2 (2*AAA size): 350mA +/-10% (1sec 700mA charge, 1sec charging OFF)
- CH3 & CH4 (1*AAA size): 350mA +/-10% (1sec 700mA charge, 1sec charging OFF)

CH1 & CH2 + CH3 & CH4:

- CH1 & CH2 (2*AAA size): 350mA +/-10% (1sec 700mA charge, 1sec charging OFF)
- CH3 & CH4 (2*AAA size): 350mA +/-10% (1sec 700mA charge, 1sec charging OFF)



Professional Charger Specification

GP version

P461 (charge pack), D461 (4-slot dock), D861 (8-slot dock)

Charge time (FAST mode): For AA size 2100mAh or AAA size 850mAhCH1 & CH2 only

- CH1 & CH2 (1*cell): 1.3hr
- CH1 & CH2 (2*cell): 2.6hr

CH3 & CH4 only

- CH3 & CH4 (1*cell): 1.3hr
- CH3 & CH4 (2*cell): 2.6hr

CH1 & CH2 + CH3 & CH4

- CH1 & CH2 (1*cell) + CH3 & CH4 (1*cell): 1.3hr
- CH1 & CH2 (1*cell) + CH3 & CH4 (2*cell): 2.6hr
- CH1 & CH2 (2*cell) + CH3 & CH4 (1*cell): 2.6hr
- CH1 & CH2 (2*cell) + CH3 & CH4 (2*cell): 2.6hr

ECO mode (MUST work with D461/ D861)**For AA size battery:**CH1 & CH2 only

- (1*AA size): 865mA \pm 10% (continuous 50% duty 1730mA charge)
- (2*AA size): 432mA \pm 10% (1sec 50% duty 1730mA charge, 1sec charging OFF)

CH3 & CH4 only

- (1*AA size): 865mA \pm 10% (continuous 50% duty 1730mA charge)
- (2*AA size): 432mA \pm 10% (1sec 50% duty 1730mA charge, 1sec charging OFF)

CH1 & CH2 + CH3 & CH4:

- CH1 & CH2 (1*AA size): 865mA \pm 10% (continuous 50% duty 1730mA charge)
- CH3 & CH4 (1*AA size): 865mA \pm 10% (continuous 50% duty 1730mA charge)

CH1 & CH2 + CH3 & CH4:

- CH1 & CH2 (1*AA size): 432mA \pm 10% (1sec 50% duty 1730mA charge, 1sec charging OFF)
- CH3 & CH4 (2*AA size): 432mA \pm 10% (1sec 50% duty 1730mA charge, 1sec charging OFF)

CH1 & CH2 + CH3 & CH4:

- CH1 & CH2 (2*AA size): 432mA \pm 10% (1sec 50% duty 1730mA charge, 1sec charging OFF)
- CH3 & CH4 (1*AA size): 432mA \pm 10% (1sec 50% duty 1730mA charge, 1sec charging OFF)

CH1 & CH2 + CH3 & CH4:

- CH1 & CH2 (2*AA size): 432mA \pm 10% (1sec 50% duty 1730mA charge, 1sec charging OFF)
- CH3 & CH4 (2*AA size): 432mA \pm 10% (1sec 50% duty 1730mA charge, 1sec charging OFF)

For AAA size battery:CH1 & CH2 only

- (1*AAA size): 350mA \pm 10% (continuous 50% duty 700mA charge)
- (2*AAA size): 175mA \pm 10% (1sec 50% duty 700mA charge, 1sec charging OFF)

CH3 & CH4 only

- (1*AAA size): 350mA \pm 10% (continuous 50% duty 700mA charge)
- (2*AAA size): 175mA \pm 10% (1sec 50% duty 700mA charge, 1sec charging OFF)

CH1 & CH2 + CH3 & CH4:

- CH1 & CH2 (1*AAA size): 350mA \pm 10% (continuous 50% duty 700mA charge)
- CH3 & CH4 (1*AAA size): 350mA \pm 10% (continuous 50% duty 700mA charge)



Professional Charger Specification

GP version

P461 (charge pack), D461 (4-slot dock), D861 (8-slot dock)

CH1 & CH2 + CH3 & CH4:

- CH1 & CH2 (1*AAA size): 175mA +/-10% (1sec 50% duty 700mA charge, 1sec charging OFF)
- CH3 & CH4 (2*AAA size): 175mA +/-10% (1sec 50% duty 700mA charge, 1sec charging OFF)

CH1 & CH2 + CH3 & CH4:

- CH1 & CH2 (2*AAA size): 175mA +/-10% (1sec 50% duty 700mA charge, 1sec charging OFF)
- CH3 & CH4 (1*AAA size): 175mA +/-10% (1sec 50% duty 700mA charge, 1sec charging OFF)

CH1 & CH2 + CH3 & CH4:

- CH1 & CH2 (2*AAA size): 175mA +/-10% (1sec 50% duty 700mA charge, 1sec charging OFF)
- CH3 & CH4 (2*AAA size): 175mA +/-10% (1sec 50% duty 700mA charge, 1sec charging OFF)

CAPACITY CHECK mode (MUST work with D461/ D861)

Process sequence (for AA size):

- ➔ Slow charge 220mA +/- 20% (1sec 440mA +/-20% charge, 1sec charging OFF), until battery charge full
- ➔ Stop for 30mins cool down
- ➔ Slow discharge 220mA +/-10% @1.3V (1sec 320mA~500mA discharge, 1sec discharge OFF), until battery voltage at 1.0V
- ➔ Calculate the battery capacity
- ➔ Stop for 30mins cool down
- ➔ FAST charge full the battery (ready for user), charging current 865mA +/- 10% (for any cell combinations)
- ➔ Transfer the measurement result to dock unit (D461 /D861)
- ➔ Process complete

Remark:

The whole process takes 10~20hrs, depending on battery capacity.

During process, battery LED indicator 1sec flashing GREEN

CONDITIONING mode (MUST work with D461/ D861)

Process sequence (for AA size):

- ➔ Slow charge 220mA +/- 20% (1sec 440mA +/-20% charge, 1sec charging OFF)
- ➔ If battery voltage unable to reach 1.0V over 3min, then shown warning (battery led indication flashing RED)
- ➔ If battery voltage able to reach 1.0V within 3min, then continue slow charge 220mA +/- 20% (1sec 440mA +/-20% charge, 1sec charging OFF)
- ➔ Slow charge full the battery (ready for user)
- ➔ Process complete

Remark:

The whole process takes 10~15hrs, depending on battery capacity.

During process, battery LED indicator 1sec flashing GREEN

REFRESH mode (MUST work with D461/ D861)

Process sequence (for AA size):

- ➔ Slow discharge 220mA +/-10% @1.3V (1sec 320mA~500mA discharge, 1sec discharge OFF), until battery voltage at 1.0V
- ➔ Calculate the battery capacity
- ➔ Stop for 30mins cool down
- ➔ FAST charge full the battery (ready for user), charging current 865mA +/- 10% (for any cell combinations)
- ➔ Transfer the measurement result to dock unit (D461 /D861)
- ➔ Process complete

Remark:

The whole process takes 10~15hrs, depending on battery capacity.

During process, battery LED indicator 1sec flashing GREEN



Professional Charger Specification

GP version

P461 (charge pack), D461 (4-slot dock), D861 (8-slot dock)

RECOVERY mode (MUST work with D461/ D861)

Process sequence (for AA size):

- ➔ Slow discharge 220mA +/-10% @1.3V (1sec 320mA~500mA discharge, 1sec discharge OFF), until battery voltage at 1.0V
- ➔ Stop for 30mins cool down
- ➔ Slow charge 220mA +/- 20% (1sec 440mA +/-20% charge, 1sec charging OFF), until battery charge full
- ➔ Stop for 30mins cool down
- ➔ Repeat above 3 cycles
- ➔ Process complete

Remark:

The whole process takes 60~80hrs, depending on battery capacity.
During process, battery LED indicator 1sec flashing GREEN

Trickle charge current (Input DC 5.0V /2A)

CH1 & CH2: 1*AA size about 170mA
2*AA size about 85mA
CH3 & CH4: 1*AA size about 170mA
2*AA size about 85 mA

CH1 & CH2: 1*AAA size about 70mA
2*AAA size about 35mA
CH3 & CH4: 1*AAA size about 70mA
2*AAA size about 35mA

Charge current & auto-reduction at high temperature

Room temperature operation: < 28C
High temperature operation: 28~33C

Fast mode charging current:

AA size (1 cell): 1730mA +/-10% (CH1 & CH2 OR CH3 & CH4)
AA size (2 cell): 865mA +/-10% ((CH1 & CH2 OR CH3 & CH4)

AAA size (1 cell) : 700mA +/-10% (CH1 & CH2 OR CH3 & CH4)
AAA size (2 cell): 350mA +/-10% (CH1 & CH2 OR CH3 & CH4)

During FAST charging at high ambient temperature (28C ~33C), when battery temperature reached 49C +/-3C, it will automatically reduce charging current, Whenever battery reached overheat temperature (53~55C),it will stop charging.

Auto-reduction charging current:

CH1 & CH2 only (1 cell) or
CH3 & CH4 only (1 cell) or
CH1 & CH2 (1 cell) + CH3 & CH4 (1 cell)
AA size: current 865mA +/-10% (continuous 50% duty 1730mA charging)
AAA size: current 350mA +/-10% (continuous 50% duty 700mA charging)

Other combinations

AA size: 432mA +/-10% (1sec 50% duty 1730mA charge, 1sec charging OFF)
AAA size: 175mA +/-10% (1sec 50% duty 700mA charge, 1sec charging OFF)

Build-in Capacity check button

A build-in capacity check button, press & hold to check the battery is GOOD or BAD capacity
GOOD, green led ON (above 50% capacity): Battery voltage > 1.32V +/- 0.05V
BAD, red led ON (below 50% capacity): Battery voltage < 1.32V +/- 0.05V



Professional Charger Specification

GP version

P461 (charge pack), D461 (4-slot dock), D861 (8-slot dock)

Power source warning detection

During operation, if input power unstable and drop below requirement, the LED indication will flash RED
 Input power warning voltage: 4.6V +/- 0.1V

Application: Charge 1/2/3/4 pcs Ni-MH AA/AAA batteries**Indication: (4pcs Dual color LED):**

Condition	LED Indication	
	RED	GREEN
Power ON	Off	ON 0.5S
No battery inserted	Off	Off
Charging in progress	Off	Slow flashing
When charging is finished and then switch to trickle charge	OFF	ON
Bad/ Primary battery inserted	Fast flashing	OFF

Charge Termination & battery protection**Safety timer:**

- 3hr (FAST charge @ room temp operation)
- 6hr (FAST charge @ high temp operation)
- 18hr (Slow charge)

Battery voltage: > 1.45V**-dV:** 5mV**Battery temperature protection:** > 53~55C**Primary battery protection****Reverse polarity protection****Battery leakage current:** below 100uA per battery

Professional Charger Specification

GP version

P461 (charge pack), D461 (4-slot dock), D861 (8-slot dock)

ENVIRONMENTAL COMPLIANCE

Operating temperature range : 0 ~ +33C

Storage temperature range : -20 ~ +60C

ROHS/REACH compliance

SAFETY & EMC COMPLIANCE

EMC : EN55014-1:2017, EN55014-2:2015, EN61000-3-2:2014 & EN61000-3-3:2013

FCC : FCC Part 15, Subpart B, ANSI C63.4-2014.

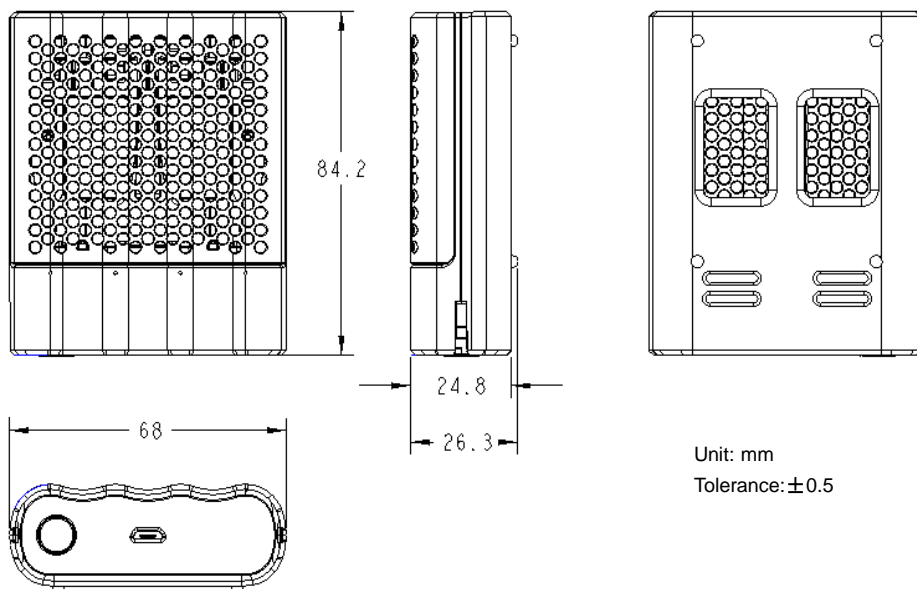
Outline dimension

Unit: mm

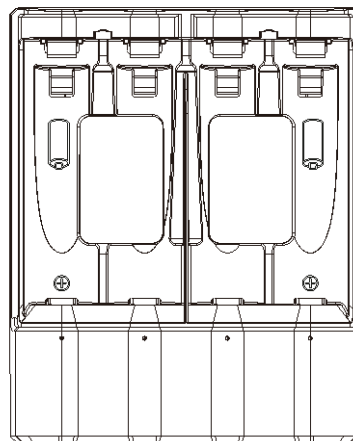
Tolerance: ± 0.5 **Outline without Battery Cover****Silkscreen requirement**



Professional Charger Specification

GP version

P461 (charge pack), D461 (4-slot dock), D861 (8-slot dock)



Pantone 376C

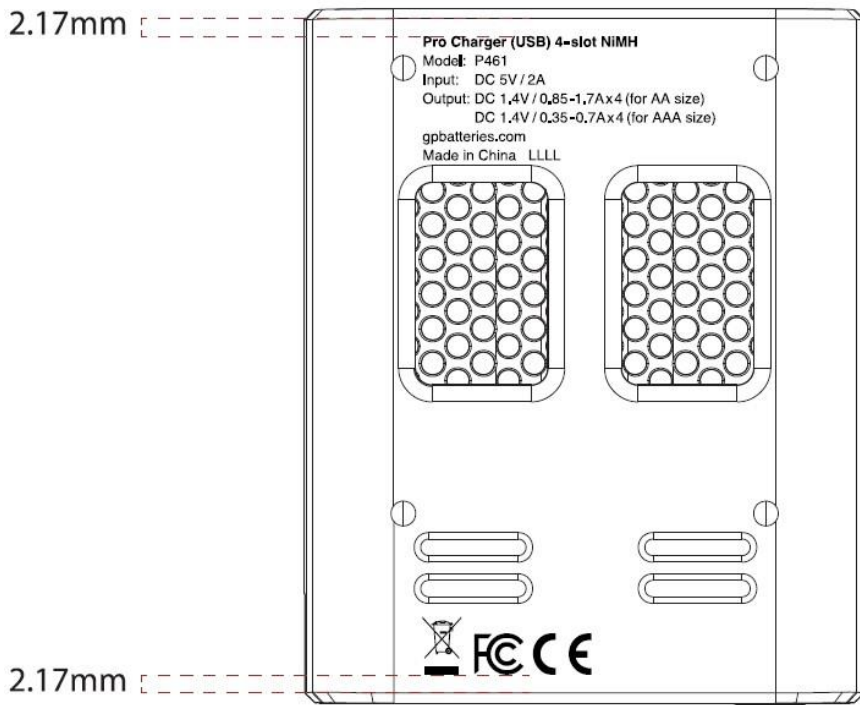

Pantone Black tone on tone

Professional Charger Specification

GP version

P461 (charge pack), D461 (4-slot dock), D861 (8-slot dock)

MECHANICAL CHARACTERISTICS

Housing (Plastic): Outer housing shall be constructed of a UL94V0 approved flame retardant material as a minimum.

Button

No distinct resistance and no function fail when pressing the button.

Durability : 1000cycles, 5s/time, No visibly damaged, No defects that would impair normal operations.

Drop resistance : No visibly damaged at 1m & 6 times, on concrete floor. No defects that would impair normal operations.

Assembly test with charging station:

Normal function test: When the charger is inserted or removed, there is no excessive resistance to make movement difficult, No defects that would impair normal operations.

Durability for insertion and withdrawal : 1000 cycles, cycle rate of 360 cycles per hour. No visibly damaged, No defects that would impair normal operations.

Protection from reverse insertion of battery : No positive terminal electrical contact

Pull force with inserted GP 2600mAH NiMH battery <20N

Compressed strength with inserted GP 1300mAH NiMH battery : No dropping of when the unit having battery facing the floor without Battery Cover.

USB Connectors

Durability for insertion and withdrawal : 1000 cycles, cycle rate of 500 cycles per hour if using auto tester, 200 cycles per hour if manual

No visibly damaged, No defects that would impair normal operations

Meet the insertion & withdrawal force requirement after 1000 cycles at a maximum rate of 12.5mm/min. (refer to USB requirements)

MicroUSB insertion force < 35N

MicroUSB withdrawal force > 8N

Good visible alignment

Cosmetic & Graphics : Detail requirement defined by ID Design Team

No visible scratch & dirt & flashes & chromatic aberration on surface.

Assembly gap of all mating parts : no movable gap

Graphic & printing robustness & endurance : refer GP – PQ

Professional Charger Specification

GP version

P461 (charge pack), D461 (4-slot dock), D861 (8-slot dock)

D461: 4-slot dock



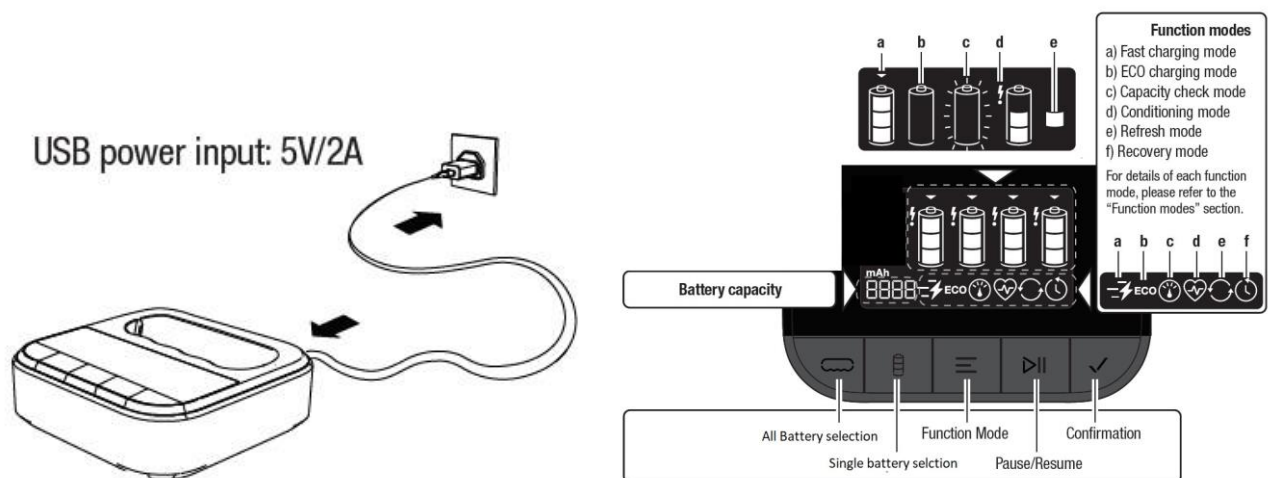

Scope:

This is a 4-slot dock unit to work with P461, also compatible with existing M451, B421. It provides five functional keys and LCD display for user to select the battery charging mode setting and display the battery charging status.

If no other specified on the test condition, all of the data specified are at room temperature – 25C.



Function keys

-  All cell: Press to select all battery
-  Single cell: Press to select single battery
-  Mode: Press to select function mode
-  Pause/Resume: Press to pause, press again to resume
-  Confirm: Press to confirm mode selected.

Professional Charger Specification

GP version

P461 (charge pack), D461 (4-slot dock), D861 (8-slot dock)

Basic operation

For detail UI operation, please refer Appendix.

Edit mode sequence:

select "Battery" (1/2/3/4/all batteries) → select "Mode" → Press "Confirm".

- Plug in microUSB power (5V/2A) at back of device, LCD shows standby display

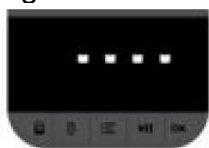

- Plug in P461 (with batteries) into slot, LCD shows charging pack detection animation.

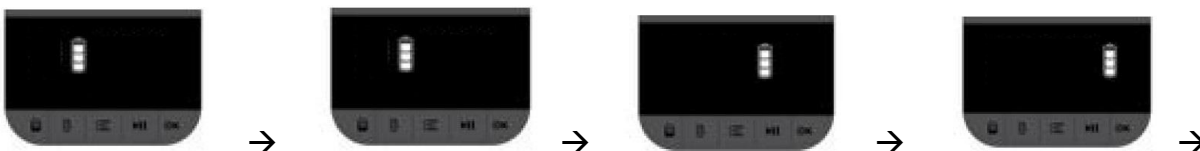

- When detection done, LCD shows below and waiting user for mode selection.

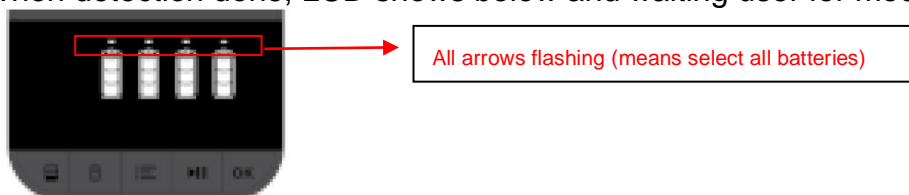

If ALL arrows flashing, means selected all batteries for setting.

If ONE arrow flashing, means selected individual battery for setting.

User can press "Single cell" key to toggle the individual battery for setting.

User can press "All cell" key to select all batteries for setting.

REMARK: If without mode selection within **5 sec**, it will select default "FAST" charge to P461 for all battery.

- User can press Mode key to select function modes, as below.



FAST: fast charging



ECO: standard charging



CAPACITY CHECK: check battery capacity after full charge



CONIDTIONING: rescue batteries (below 1V) due to long storage.



REFRESH: check remained capacity of the batteries.



RECOVERY: recovery the battery to health condition by 3cycles slow charge & slow discharge.

REMARK: For above functions in details, please refer at P461 section.

Professional Charger Specification

GP version

P461 (charge pack), D461 (4-slot dock), D861 (8-slot dock)

- When Mode is selected for individual battery, press “Confirm” key. It will go to next battery for Mode selection. Repeat Mode selection for all batteries. When the Mode for last battery is also confirmed, it will exit the Edit mode and start to run the program.

When All battery is selected, just need to select the Mode and press “Confirm” key, it will exit the Edit mode and start to run the program.

During charging

When the program for battery is running, the level icons inside battery will flashing/ animation.

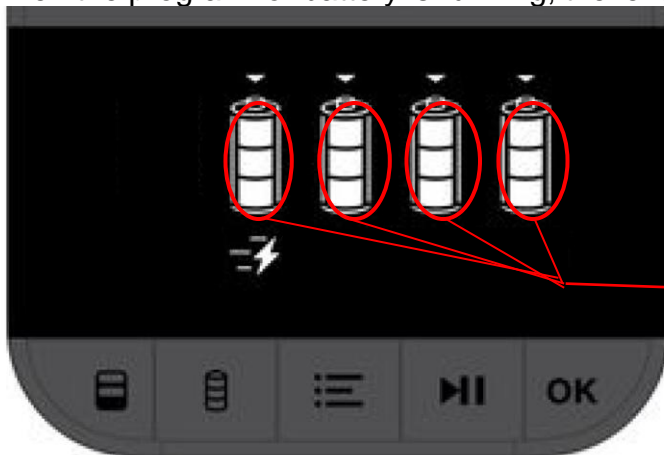

When program is running,
battery levels icon
flashing/ animation.

When the program for battery is completed, the level icons inside battery stay solid.

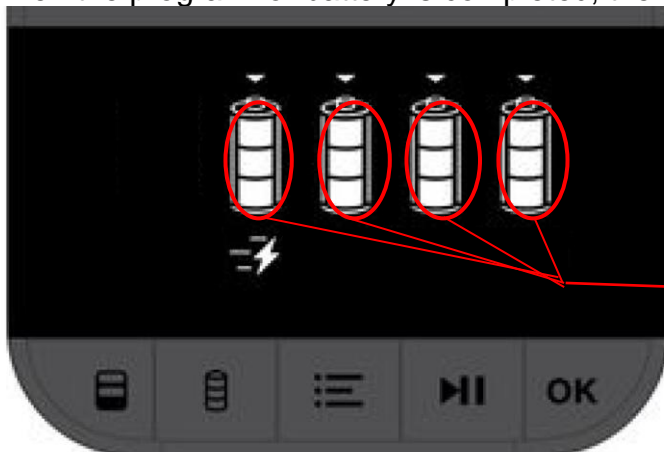

When program is
completed, battery levels
icon stays **solid.**

Professional Charger Specification

GP version

P461 (charge pack), D461 (4-slot dock), D861 (8-slot dock)

Capacity Check and Refresh function

If the battery has been selected “Capacity check” or “Refresh” function and completed, capacity measurement result will show when it is at view status mode.

Capacity check

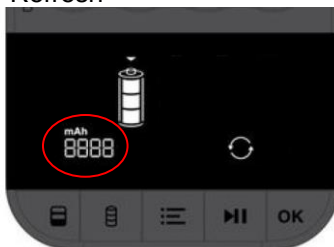

Refresh

**Viewing status**

During charging in operation, user can press “Single cell” to go into viewing status to check individual battery status.

Press “Single cell” again to go to next battery.

Toggle cycle: Cell 1/2/3/4

Edit mode

During charging in operation, user can press & hold “Mode” key for 2sec, it will go into the Edit mode to change individual/ all battery program setting. Follow basic operation procedures to change setting accordingly.

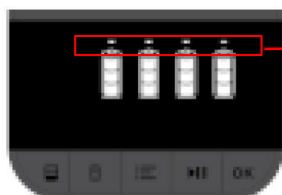

All arrows flashing (means select all batteries)

During Edit mode, user can press & hold “Mode” key for 2sec to exit, it will run the program that has been set. If no key press for 45sec (timeout), it will automatically to exit the Edit mode also.

Pause/ Resume

During charging in operation, user can press “Pause/Resume” key, device will store the charging program setting. User can unplug P461 to check/change the batteries, then can re-plug the P461 into the dock, user can press “Pause/Resume” key again to restore the charging program setting.

LCD display animation as below.



Professional Charger Specification

GP version

P461 (charge pack), D461 (4-slot dock), D861 (8-slot dock)

Battery Slot Missing

When the P461 is unplug, the LCD will display below.

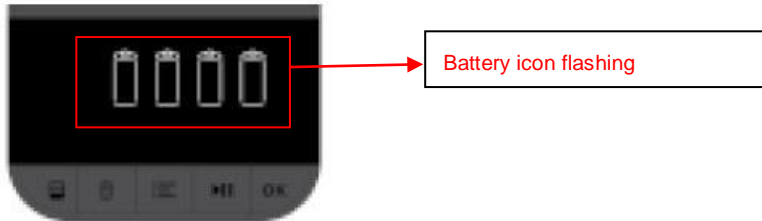
**Standby**

If no P461 on dock, the LCD will display below.

**Auto display OFF & wakeup**Auto-OFF

When the device is idle for 2mins, it will turn OFF the LCD display

Auto-wakeup

- P461/ M451/ B421 plug into dock, it will wake up automatically
- Press "All battery" or "Confirm" key, it will wake up automatically.

Compatibility

When works with P461 (Professional SCO), it provides all the features as mentioned below. When works with M451 (Mainstream SCO) or B421 (Basic SCO), it provides the charging functions ONLY. The charging current follows their original electrical specification.

Power source

MicroUSB 5V/ 2A provide by USB wall charger or Powerbank



Professional Charger Specification

GP version

P461 (charge pack), D461 (4-slot dock), D861 (8-slot dock)

Electrical consumption (Power supply 5Vdc),**Average measurement**

Standby mode (without P461): 32mA +/-10%

OFF display mode (without P461): 32mA +/-10%

FAST charge mode (P461 with all batteries): 1450mA +/-10%

ECO charge mode (P461 with all batteries): 750mA +/-10%

CAPACITY CHEK charge mode (P461 with all batteries): 330mA +/- 10%

CONDITIONING charge mode (P461 with all batteries): 330mA +/- 10%

REFRESH charge mode (P461 with all batteries): 73mA +/- 10%

RECOVERY charge mode (P461 with all batteries): 73mA +/- 10%

ENVIRONMENTAL COMPLIANCE

Operating temperature range : 0 ~ +33C

Storage temperature range : -20 ~ +60C

ROHS/REACH compliance

SAFETY & EMC COMPLIANCE

EMC : EN55014-1:2017, EN55014-2:2015, EN61000-3-2:2014 & EN61000-3-3:2013

FCC : FCC Part 15, Subpart B, ANSI C63.4-2014.

Professional Charger Specification

GP version

P461 (charge pack), D461 (4-slot dock), D861 (8-slot dock)

Outline dimension

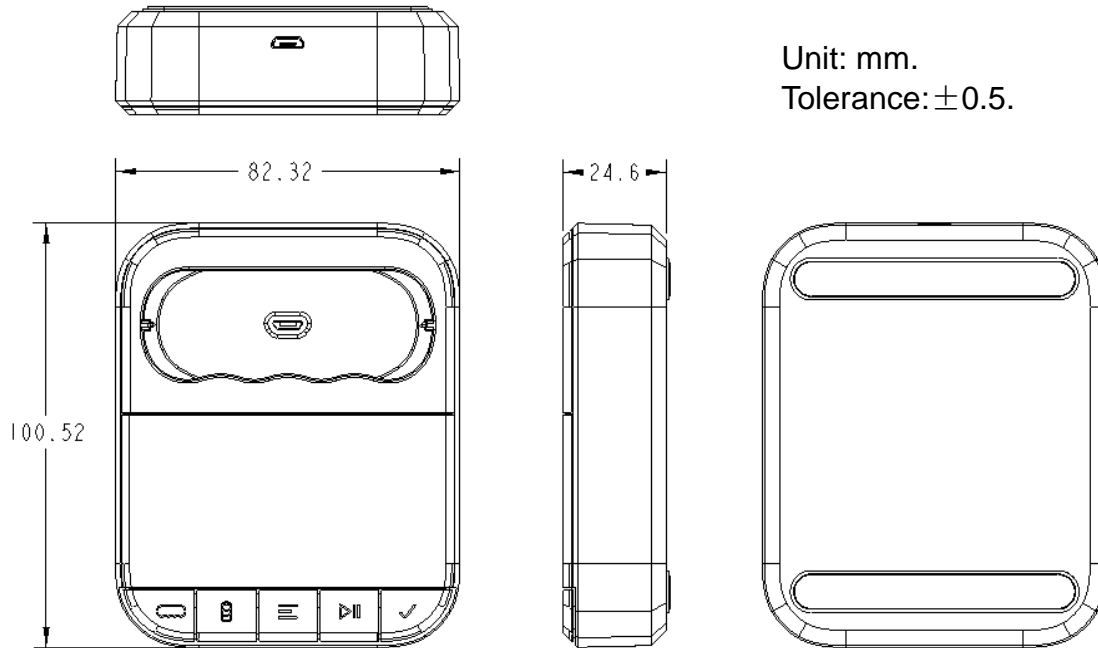

Silkscreen requirement

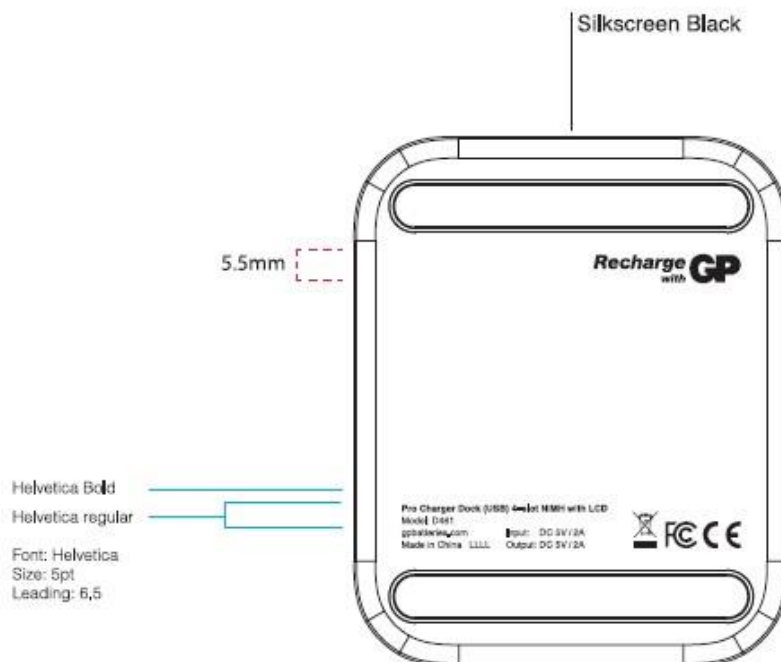



Professional Charger Specification

GP version

P461 (charge pack), D461 (4-slot dock), D861 (8-slot dock)

MECHANICAL CHARACTERISTICS

Housing (Plastic): Outer housing shall be constructed of a UL94V0 approved flame retardant material as a minimum.

Button

No distinct resistance and no function fail when pressing the button.

Durability : 1000cycles, 5s/time, No visibly damaged, No defects that would impair normal operations.

Drop resistance : No visibly damaged at 1m & 6 times, on concrete floor. No defects that would impair normal operations.

Assembly test with charging station:

Normal function test: When the charger is inserted or removed, there is no excessive resistance to make movement difficult, No defects that would impair normal operations.

Durability for insertion and withdrawal : 1000 cycles, cycle rate of 360 cycles per hour. No visibly damaged, No defects that would impair normal operations.

Protection from reverse insertion of battery : No positive terminal electrical contact

Charging pack (P461) Pull & Insert force <30N

USB Connectors

Durability for insertion and withdrawal : 1000 cycles, cycle rate of 500 cycles per hour if using auto tester, 200 cycles per hour if manual

No visibly damaged, No defects that would impair normal operations

Meet the insertion & withdrawal force requirement after 1000 cycles at a maximum rate of 12.5mm/min. (refer to USB requirements)

MicroB insertion force < 35N

MicroB withdrawal force > 8N

Good visible alignment

Cosmetic & Graphics : Detail requirement defined by ID Design Team

No visible scratch & dirt & flashes & chromatic aberration on surface.

Assembly gap of all mating parts : no movable gap

Graphic & printing robustness & endurance : refer GP – PQ

Professional Charger Specification

GP version

P461 (charge pack), D461 (4-slot dock), D861 (8-slot dock)

D861: 8-slot dock



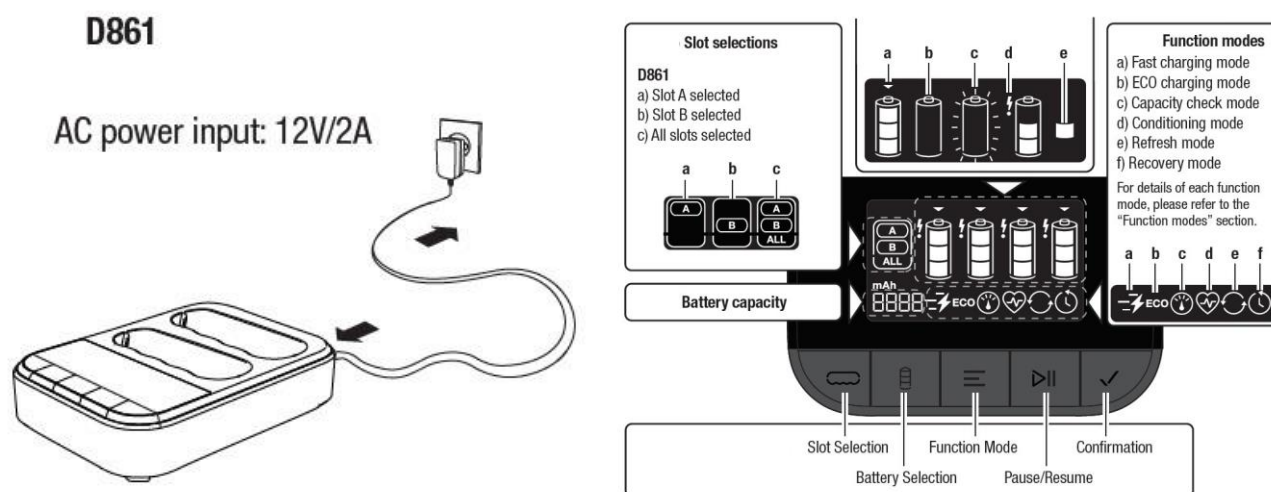

Scope:

This is a 8-slot dock unit to work with P461, also compatible with existing M451, B421. It provides five functional keys and LCD display for user to select the battery charging mode setting and display the battery charging status.

If no other specified on the test condition, all of the data specified are at room temperature – 25C.



Function keys

-  Slot: Press to select all battery
-  Battery: Press to select single battery
-  Mode: Press to select function mode
-  Pause/Resume: Press to pause, press again to resume
-  Confirm: Press to confirm mode selected.

Professional Charger Specification

GP version

P461 (charge pack), D461 (4-slot dock), D861 (8-slot dock)

Basic operation

For detail UI operation, please refer Appendix.

Edit mode sequence:

select "Slot" (A/B/ALL) → select "Battery" (1/2/3/4/all batteries) → select "Mode" → Press "Confirm".

→ Plug in AC/DC wall adaptor (12V/2A) at back of device, LCD shows standby display

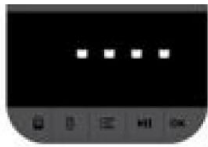

→ Plug in P461 (with batteries) into slot, LCD shows charging pack detection animation.



→ When detection done, LCD shows below and waiting user for battery selection.

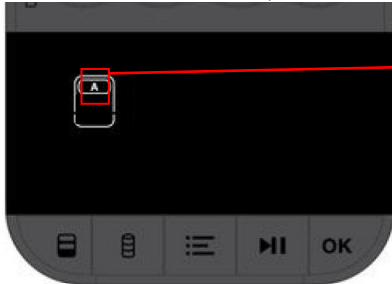

If P461 plug in Slot A, slot "A" icon flashing
If P461 plug in Slot B, slot "B" icon flashing

User can press "Battery" key to select battery for mode setting. Toggle cycle ALL/ 1/ 2/ 3/ 4.

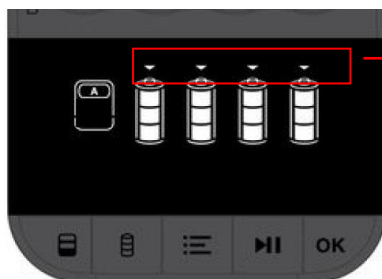

Battery arrows flashing.
Press battery key to toggle all/ 1/ 2/ 3/ 4

REMARK: If without battery selection within **5 sec**, it will select default "FAST" charge to P461 for all battery.

Professional Charger Specification

GP version

P461 (charge pack), D461 (4-slot dock), D861 (8-slot dock)

→ User can press Mode key to select function modes, as below.

 FAST: fast charging

 ECO: standard charging

 CAPACITY CHECK: check battery capacity after full charge

 CONIDTIONING: rescue batteries (below 1V) due to long storage.

 REFRESH: check remained capacity of the batteries.

 RECOVERY: recovery the battery to health condition by 3cycles slow charge & slow discharge.

REMARK: For above functions in details, please refer at P461 section.

→ When Mode is selected for individual battery, press “Confirm” key. It will go to next battery for Mode selection. Repeat Mode selection for all batteries. When the Mode for last battery is also confirmed, it will exit the Edit mode and start to run the program.

When All battery is selected, just need to select the Mode and press “Confirm” key, it will exit the Edit mode and start to run the program.

During charging

When the program for battery is running, the level icons inside battery will flashing/ animation.

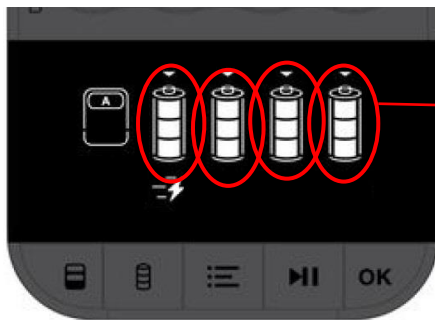

When program is running,
battery levels icon
flashing/ animation.

When the program for battery is completed, the level icons inside battery stay solid.

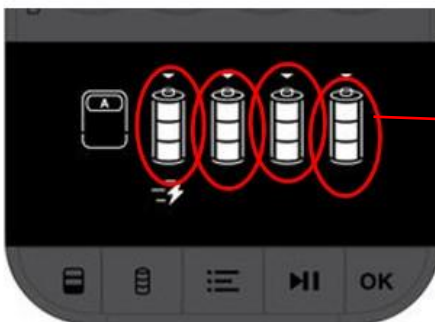

When program is
completed, battery levels
icon stays **solid.**

Professional Charger Specification

GP version

P461 (charge pack), D461 (4-slot dock), D861 (8-slot dock)

Capacity Check and Refresh function

If the battery has been selected “Capacity check” or “Refresh” function and completed, capacity measurement result will show when it is at view status mode.

Capacity check

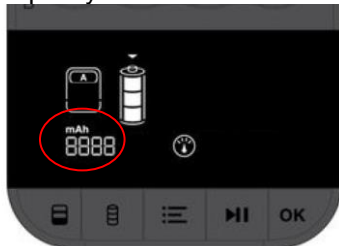

Refresh

**Viewing status**

During charging in operation, user can press “Battery” to go into viewing status to check individual battery status.

Press “Battery” again to go to next battery.

Toggle cycle: Battery 1/2/3/4

Edit mode

During charging in operation, user can press & hold “Mode” key for 2sec, it will go into the Edit mode to change individual/ all battery program setting. Follow basic operation procedures to change setting accordingly.

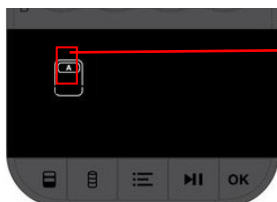

If P461 plug in Slot A, slot “A” icon flashing
If P461 plug in Slot B, slot “B” icon flashing

During Edit mode, user can press & hold “Mode” key for 2sec to exit, it will run the program that has been set. If no key press for 45sec (timeout), it will automatically exit the Edit mode also.

Pause/ Resume

During charging in operation, user can press “Pause/Resume” key, device will store the charging program setting. User can unplug P461 to check/change the batteries, then can re-plug the P461 into the dock, user can press “Pause/Resume” key again to restore the charging program setting.

LCD display animation as below.

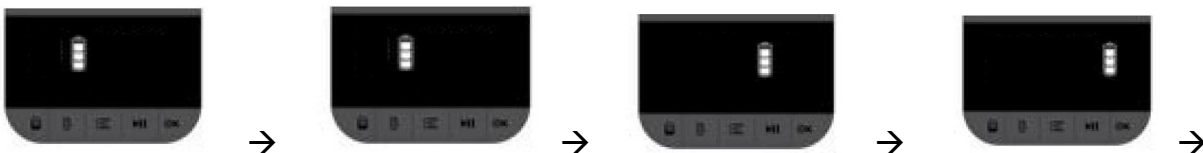

Professional Charger Specification

GP version

P461 (charge pack), D461 (4-slot dock), D861 (8-slot dock)

Change Slot A/B during charging

When both slot A and slot B have P461, user can press “Slot” key to change to another slot for battery charging status/ view individual battery status. Toggle cycle A/ B/ ALL

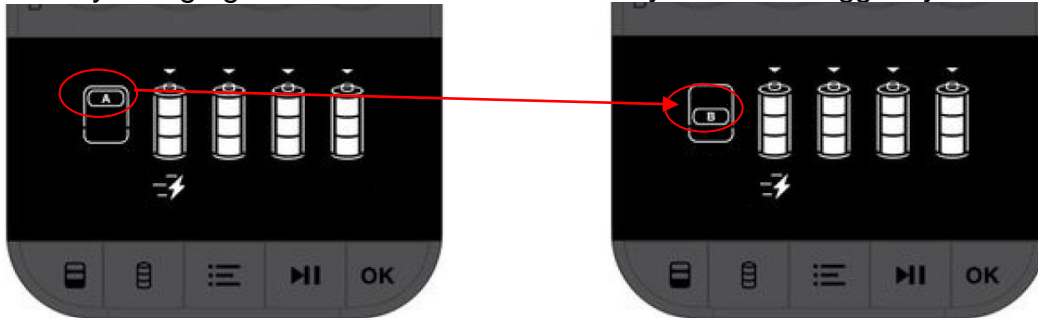
**Battery Slot Missing**

When both slot A and slot B are missing P461, the LCD will display below.

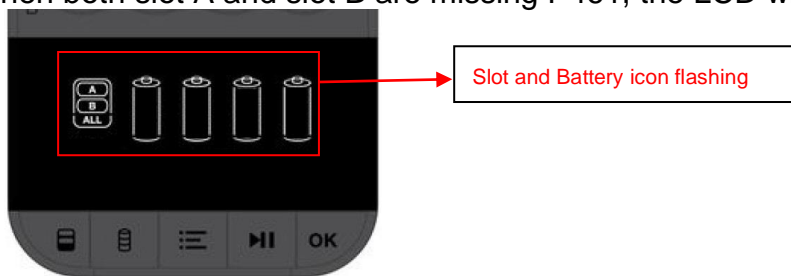
**Standby**

If no P461 on dock, the LCD will display below.

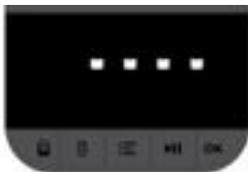
**Auto display OFF & wakeup**Auto-OFF

When the device is idle for 2mins, it will turn OFF the LCD display

Auto-wakeup

- P461/ M451/ B421 plug into dock, it will wake up automatically
- Press “Slot” or “Confirm” key, it will wake up automatically.

**Professional Charger Specification****GP version**

P461 (charge pack), D461 (4-slot dock), D861 (8-slot dock)

Compatibility

When works with P461 (Professional SCO), it provides all the features as mentioned below. When works with M451 (Mainstream SCO) or B421 (Basic SCO), it provides the charging functions ONLY. The charging current follows their original electrical specification.

Power source

AC/DC wall adaptor 12V/ 2A

Electrical consumption (Power supply 12Vdc), both Slot A & B with P461,**Average measurement**

Standby mode (without P461): 60mA +/-10%

OFF display mode (without P461): 60mA +/-10%

FAST charge mode (Both P461 with all batteries): 1300mA +/-10%

ECO charge mode (Both P461 with all batteries): 750mA +/-10%

CAPACITY CHEK charge mode (Both P461 with all batteries): 300mA +/- 10%

CONDITIONING charge mode (Both P461 with all batteries): 300mA +/- 10%

REFRESH charge mode (Both P461 with all batteries): 110mA +/- 10%

RECOVERY charge mode (Both P461 with all batteries): 110mA +/- 10%

ENVIRONMENTAL COMPLIANCE

Operating temperature range : 0 ~ +33C

Storage temperature range : -20 ~ +60°C

ROHS/REACH compliance

SAFETY & EMC COMPLIANCE

EMC : EN55014-1:2017, EN55014-2:2015, EN61000-3-2:2014 & EN61000-3-3:2013

FCC : FCC Part 15, Subpart B, ANSI C63.4-2014.

Professional Charger Specification
GP version

P461 (charge pack), D461 (4-slot dock), D861 (8-slot dock)

Outline dimension

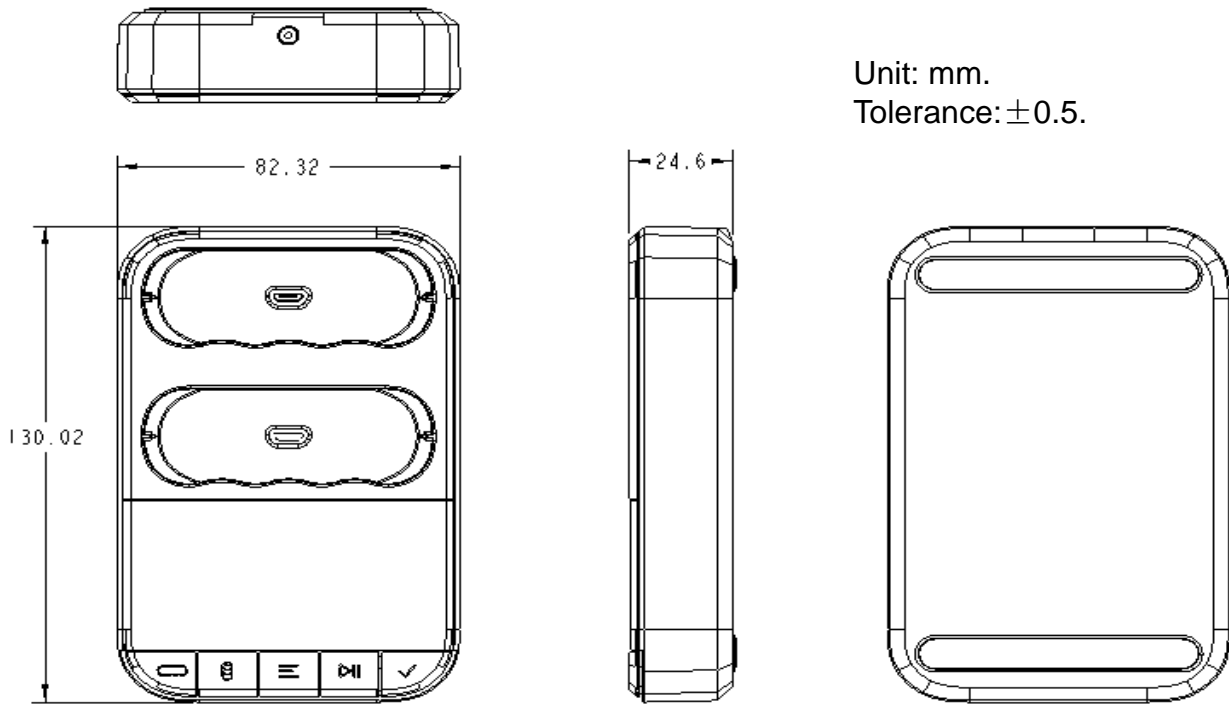



Professional Charger Specification

GP version

P461 (charge pack), D461 (4-slot dock), D861 (8-slot dock)

Silkscreen requirement

Silkscreen Black

5.5mm

Helvetica Bold
Helvetica regular

Font: Helvetica
Size: 5pt
Leading: 6.5



Professional Charger Specification

GP version

P461 (charge pack), D461 (4-slot dock), D861 (8-slot dock)

MECHANICAL CHARACTERISTICS

Housing (Plastic): Outer housing shall be constructed of a UL94V0 approved flame retardant material as a minimum.

Button

No distinct resistance and no function fail when pressing the button.

Durability : 1000cycles, 5s/time, No visibly damaged, No defects that would impair normal operations.

Drop resistance : No visibly damaged at 1m & 6 times, on concrete floor. No defects that would impair normal operations.

Assembly test with charging station:

Normal function test: When the charger is inserted or removed, there is no excessive resistance to make movement difficult, No defects that would impair normal operations.

Durability for insertion and withdrawal : 1000 cycles, cycle rate of 360 cycles per hour. No visibly damaged, No defects that would impair normal operations.

Protection from reverse insertion of battery : No positive terminal electrical contact

Charging pack (P461) Pull & Insert force <30N

USB Connectors

Durability for insertion and withdrawal : 1000 cycles, cycle rate of 500 cycles per hour if using auto tester, 200 cycles per hour if manual

No visibly damaged, No defects that would impair normal operations

Meet the insertion & withdrawal force requirement after 1000 cycles at a maximum rate of 12.5mm/min. (refer to USB requirements)

MicroB insertion force < 35N

MicroB withdrawal force > 8N

Good visible alignment

Cosmetic & Graphics : Detail requirement defined by ID Design Team

No visible scratch & dirt & flashes & chromatic aberration on surface.

Assembly gap of all mating parts : no movable gap

Graphic & printing robustness & endurance : refer GP – PQ